

سابک
sabic



SABIC® LDPE
SHRINK FILM

Sharing our futures

**SABIC® LDPE
SHRINK FILM**



CONTENTS

POLYETHYLENE SHRINK FILM FOR PACKAGING	6
Heavy-duty shrink film	7
<i>Mono-axial pallet hood (Flat hood)</i>	
<i>Bi-axial pallet hood (Side-folded hood)</i>	
<i>Automation in pallet shrinking</i>	
Light shrink film	10
<i>Transport film</i>	
<i>Protective shrink film</i>	
<i>High optics shrink film</i>	
Shrink percentages	11
THE SHRINK PROCESS	12
MEASURING SHRINK	16
Measuring the shrink percentage	16
Measuring the shrink tension	18
THE BLOWN FILM PROCESS OF LDPE FOR SHRINK FILM	22
Orientation	22
Influence of processing conditions on MD shrinkage	24
Influence of processing conditions on TD shrinkage	25
Influence of the grade characteristics on shrink properties	26
MD and TD shrinkage of SABIC®LDPE film	28
<i>Calculation examples</i>	
SHRINK FILM DEFECTS	31
Inadequate shrinkage	31
Holes and tears	31
Folds and creases	32

Polyethylene shrink film for packaging

Clearly the perfect solution



Shrink film is a major application within the polyethylene resin segment. The majority of the resin consumption in this application is by LDPE (low density polyethylene). Although its development has reached a more or less mature state, shrink film is still a youngster if we compare its age with other traditional packaging materials like, for instance, paper and cardboard. Its advantages and specific properties explain the growth and present importance of shrink film.

Even before the introduction of shrink film, polyethylene was used for the packaging of all sorts of products. However, the deliberate use of the orientation built in during the manufacturing process was the cause for the rapid growth of shrink film in the past. Like any other packaging material, polyethylene shrink film has the following properties:

- Separation of a single product or group of products from a mass into a practical transportable unit
- Protecting the product against external influences
- Protecting the environment from the product

In addition to these properties, polyethylene shrink film acts like a perfect skin, capable of resisting the stresses encountered during transport.

Following the shortest possible outlines of the total package, shrink film is capable of performing its function with a minimum weight-to-strength ratio.

Further advantages are:

- Good visibility of the individual packages, easy recognition of the goods, less administration during storage
- Theft-proof package, lower insurance premium
- Stable package, easy stacking and transport, lower shipping costs due to better stowage and fewer failures
- Rain-resistant package

Although this method of packaging is very widely used, there are still a large number of failures caused by inadequate knowledge of the application of shrink film. Failures can occur due to incorrect selection of the shrink properties of the polyethylene film in relation to the dimensions of the goods to be packed. Before we apply this information about shrink properties, it is necessary to give a summary of the various types of shrink film in present-day use. The most important types are:

- Mono-axial shrink film
- Bi-axial shrink film

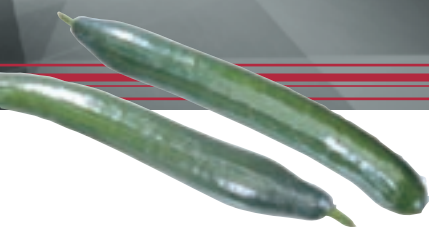

Later in this brochure, the description of the method used in manufacturing shrink film might give the idea that mono-axial film shrinks exclusively in one direction, but this is not true. One speaks of mono-axial shrink film when shrinkage mainly takes place in machine, i.e. extrusion, direction; this is called MD shrinkage or longitudinal shrinkage.

Bi-axial shrink film shrinks in machine direction and also in the direction perpendicular, or transverse, to the machine direction (TD shrinkage).

Further distinctions indicating the quality and the application of the film:

- Heavy-duty shrink film (mostly thicknesses above 100 microns)
- Light-duty shrink film (mostly thicknesses below 100 microns)
- Tough, strong transport film
- Less tough film for protection against dirt and dust

Although the last two differences are subjective, they specify some of the boundaries for the choice of film and the choice of raw material.



Heavy-duty shrink film

As tough as it gets

Heavy-duty shrink film is usually used for transport on pallets. The film thickness generally varies between 100 and 200 microns. For higher mechanical properties, which are required for a tough film, an LDPE with a low MFR is chosen. For this application SABIC developed the SABIC[®] LDPE MFR 0.3 [g/10min] and density 921 [kg/m³]. The most important form in which heavy-duty shrink film is processed is the pallet hood. All pallet hoods are made via a blown film process (tubular form).

The development of the “total packaging line” made it possible to use an endless roll of film and manufacture the pallet hood on the packaging line just before shrinking.

Two main systems for pallet shrink-wrapping have been developed:

- A. Mono-axial pallet hood (Flat hood)
- B. Bi-axial pallet hood (Side-folded hood)

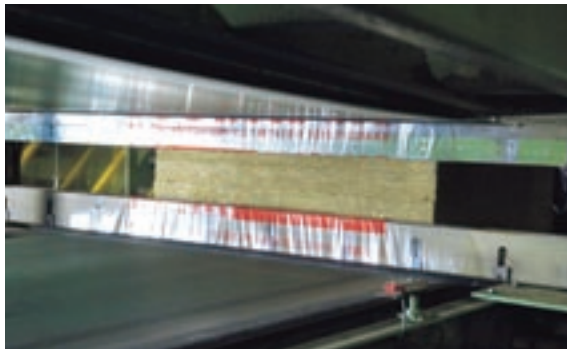



Mono-axial pallet hood (Flat hood)

This type of pallet hood is the oldest one. It is made of centre-folded tubular film, which has been opened on one side. Two seals are made across the film, perpendicular to the machine direction. The distance between the two seals should be equal to approximately 55% of the pallet load circumference. The tubular film is cut through before the first seal and after the second one. This deliberately loose-fitting hood is drawn over the pallet load and round the perimeter of the pallet itself, leaving only two triangular gussets of film at the top to be tucked in upon themselves prior to shrink processing. See figures 1 to 5. Variations in the height of the pallet load are accommodated by different blow-up ratios, unfortunately with a certain loss of mono-axial properties. Variations in pallet sizes are simply solved by an increase in the seal distance.

This system of pallet hood fabrication is especially suited for non-standardized pallet systems. The main reason for using this type of hood is the low transverse shrink.

Fig.1/5 Mono-axial pallet hood for a non-standardized pallet.

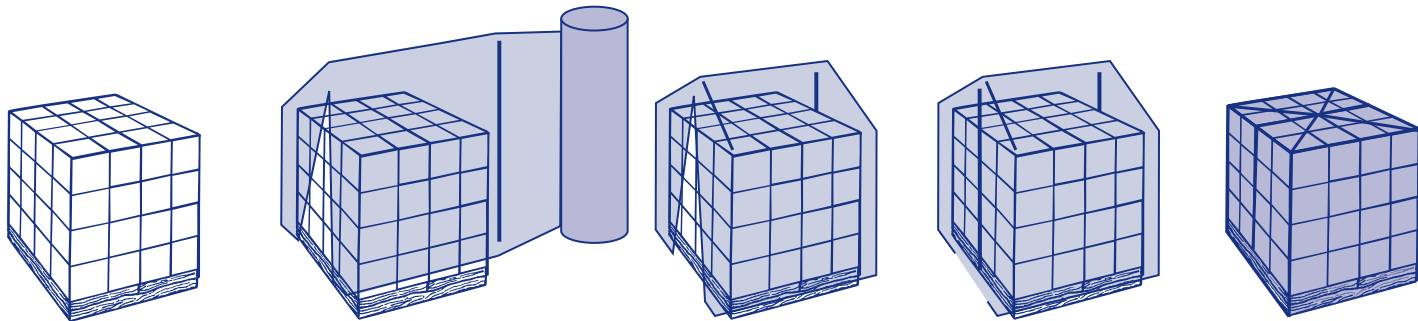

The longitudinal shrink (shrink in machine direction) is much higher in comparison with the transverse shrink and is applied in the circumferential direction of the pallet-load. The shrink in the transverse direction is much lower. When correctly formulated mono-axial pallet hood is used this gives an image as shown in fig. 6. If the transverse shrink is too high, the pallet hood will behave as shown in fig 7. The wrapping forces are then concentrated in the four lower corners of the hood and a pallet hood with a normal film thickness will not withstand all transport conditions (typical defect for bi-axial shrink hoods).

Bi-axial pallet hood (Side-folded hood)

Today, because the equipment is smaller, quicker and mostly more energy efficient, the bi-axial pallet hood is mostly used. If used in combination with old-fashioned shrink tunnels, the hood had to be stapled on the wooden pallet to prevent the behaviour - due to its greater transverse shrink - as shown in fig. 7. The development of modern shrink tunnels, with the possibility of pre-heating the pallet base, removed all the disadvantages of the bi-axial hood and gave way to a complete automation of shrink packaging.

The bi-axial pallet hood is made from blown film with folds on both sides.

The film is sealed together perpendicular to the machine direction. The hood is cut off from the film tube just above the seal. The distance between the seal and open side of the hood should be approximately equal to the height plus the half of the shortest side of the pallet load.

The front side of the hood should be approximately equal to 0.55 x the longest side of the pallet; the depth of the side fold should be approximately 0.55 x the shortest pallet side.

This means that the circumference of the hood is 1.1 x the pallet circumference. Therefore shrinkage of minimum 10% in transverse direction is required.

The bi-axial pallet hood is very suitable for standardized pallet systems. Variations in the height of the pallet load are accommodated by an increase in the seal distance. Variations in pallet sizes are simply accommodated by an increase in the blown-up ratio, which means that the film remains bi-axial.

Fig. 6 Mono-axial pallet hood with shrink in machine direction mainly, thus in the circumferential direction of the load.

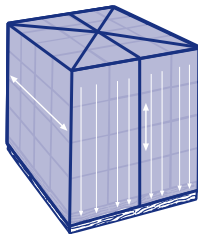

Fig. 7 Pallet hood with too strong shrinkage in transverse direction.

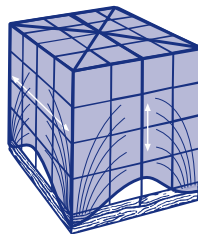

Fig. 8 Automation of pallet packaging. The film is pulled from the roll above the pallet.

The largest shrink occurs in the machine direction of the film from the top to the base of the pallet load. The transverse shrink occurring in the circumference of the pallet load is relatively high in comparison with the mono-axial hood. The hood is fixed on the pallet using the “pre-shrinking” method mentioned above.

Automation in pallet shrinking

Automation in pallet-hood wrapping has become standard over the last few years. Looking at the bi-axial and mono-axial pallet hood, there appear to be two main systems of automation.

1. Mono-axial system

The shrink film is conveyed to the pallet from a roll, which is situated in a horizontal or vertical position at the upper end of the wrapping machine.

The pallet is pushed into the shrink film with a seal in front of it. When the film covers the whole pallet, two seals are made at the back, and the film is cut through between those seals. The second seal is the front one for the next pallet hood. The pallet hood is now ready for shrinking.

2. Bi-axial system

The shrink film is conveyed to the pallet load from a roll situated on top of the wrapping machine. A side-folded film is the base of the whole operation. The film is pulled down by a special film-guiding system until the pallet load and the pallet are totally covered. Then the film is sealed and cut through just above the seal. After this operation the covered pallet load is ready for shrinking (fig. 8)



Light shrink film

The attractive alternative

The lightweight shrink film applications vary in thicknesses from 15 microns - 100 microns.

The main types of film are:

1. Shrink film for transport and bundling only.
2. Shrink film for bundling and protection against environmental influences, protective film.

Since the rapid growth of supermarkets and discount shops, there is now interest in a new type of light shrink film which is a compromise between the two types mentioned above.

3. Shrink film that combines the benefits of the two types mentioned above and that has a large degree of advertising purpose (shelf attractiveness). Mostly high-optic, high-gloss and highly-printed shrink films are used.



Transport film (fig. 9):

This film is normally used for bundling and wrapping products during transport. Protection against dirt and water is a less important feature of this film.

Because of the higher mechanical requirements, the melt-flow rate (MFR, a.k.a. melt-index) of the basic resin is low and therefore the optical properties are standard (SABIC® LDPE MFR 0.3 [g/10min] and density 925 [kg/m³]). The packages are mostly open on two sides and the film shrinks mono-axial. Thicknesses vary between 40 microns and 100 microns. If a completely closed package is wanted a bi-axial shrink film is used. To avoid ballooning of the package during the shrinking process, the film is perforated to release the excess air enclosed.

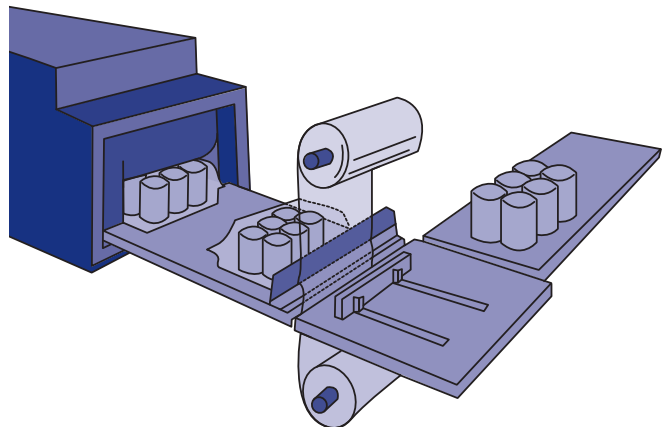

Fig. 9 Automatic packaging in transport film.

Protective shrink film (fig. 10):

This film is used to protect packed goods against environmental influences. The package is therefore completely closed by means of a perforated bi-axially shrinking LDPE-film.

Most goods packed in this type of film are also sold in it. A good display needs good transparency and does not make high demands on the mechanical properties. The packages are smaller than, and not as heavy as, the transport packages. The basic resin has a higher MFR, the optical properties of this film are important and thus high (SABIC® LDPE MFR 4 [g/10min] and density 924 [kg/m³]). Since the package should be totally enclosed, bi-axially shrink film is mostly used.

Film thicknesses vary between 15 microns (e.g. wrapping of magazines and books) and 60 microns for relatively heavy packages (5-10 kg).

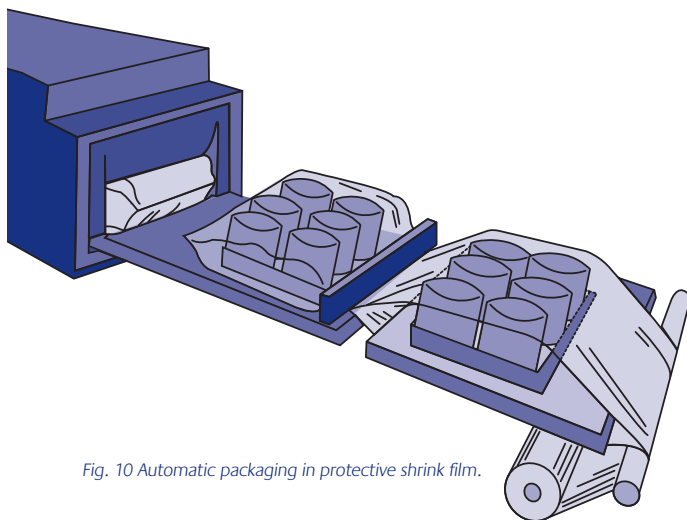

Fig. 10 Automatic packaging in protective shrink film.

High optics shrink film:

Supermarkets and discount shops sell a lot of products that have a package for transportation and displaying (shelf attractiveness) purpose at the same time.

Shrink film resins used for this purpose need to have good mechanical strength (low MFR), good optics and the possibility to produce thin gauges. For this purpose SABIC has developed its SABIC® LDPE MFR 0.8 [g/10min] and density 922 [kg/m³] with high optical properties.

Shrink percentages

Shrink percentages are dependent on the dimensions of the goods that are to be packed.

A totally closed package of long and flat articles, for instance, needs a bi-axial film with shrink percentages of $\pm 60\%$ in machine and 20-25% in transverse direction. A regularly shaped package needs a more balanced film with shrink percentages of $\pm 55\%$ in machine and $\pm 40\%$ in transverse direction.

An open package with six or twelve cans on a cardboard tray is normally packed with a mono-axial shrink film with a 50 - 60% machine direction and 5 - 10% (maximum) transverse shrink.

Before giving an advice to a client about necessary shrink percentages, a good knowledge of the goods to be packed is an absolute necessity. Therefore it is worth finding the relationship between longitudinal and transverse shrink in relation to the package, by means of film samples with different shrink behaviour.

The shrink process

The shrinkage phenomenon of films made with LDPE resins is based on the relaxation of the orientation stresses introduced into the film during manufacturing. Relaxation of these stresses takes place at approximately the same temperature at which they have been introduced.

The lowest temperature at which orientation stresses are introduced is just above the crystalline melting point of the LDPE grade concerned; depending on the grade, this is between 110°C and 120°C. When LDPE film is heated, it generally begins to shrink at a temperature of approximately 110°C. See fig. 11.

Fig. 11 Shrinkage of film cold stretched at various temperatures and of blown film, as a function of the temperature.

- 1 = 100% cold stretched at 50°C
- 2 = 100% cold stretched at 80°C
- 3 = blown film.

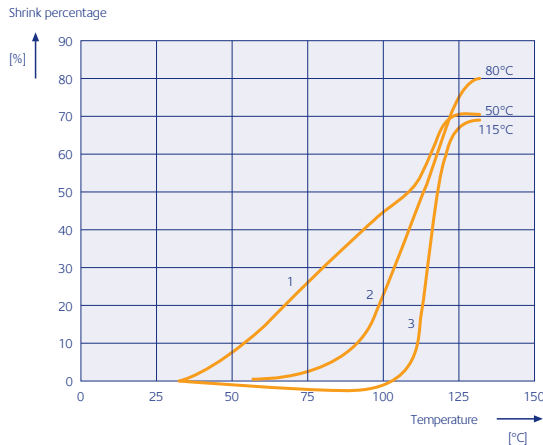

The film is heated by hot air in a shrink tunnel. The course of the shrinking process after entry in the shrink tunnel is reproduced schematically in fig. 12.

As can be seen, the film first expands when heated (3 to 5% thermal expansion).

Once the melting point has been reached, the film shrinks rapidly to an intrinsic extent. After leaving the tunnel the film cools off rapidly. As from the solidifying point the film undergoes some after-shrinkage (3 to 5% thermal shrinkage) until it reaches the same temperature as the environment.

Fig. 12 Shrink behaviour in the shrink tunnel

- 1 = thermal expansion
- 2 = shrink
- 3 = plastic flow
- 4 = thermal shrink

Air temperature in the tunnel is 140°C.

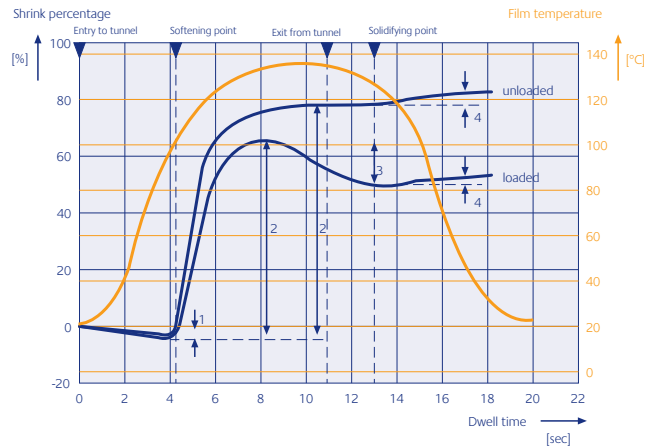



If the shrink film is applied to a load, with a geometry that falls within the minimum and maximum shrink percentage, the shrinkage is stopped due to hindrance.

In the plastic phase (above the crystalline melting point) the film is not strong enough to withstand even very small mechanical stresses. When, for instance, the packed articles topple over, the film stretches (plastic yield). This plastic yield continues until the solidifying point is reached, after which thermal shrinkage takes place. In practice this will not often occur, since stress would not normally be applied in the course of the shrinking process.

During the shrinking process in the shrink tunnel and during the cooling-off period after leaving the shrink tunnel, the film can exert forces on the packed articles. After the wrap has shrunk and fits tightly around the packed article (mostly the wrap is approx. 10% larger than the packed article), no further shrinkage can take place (geometric hindrance) while the film is likely to continue shrinking. The film now exerts a force on the article (see fig. 13). The force exerted in the plastic phase - the plastic shrinking force - is small. Depending on the polyethylene grade, the percentage of shrink and the thickness of the film, the plastic shrinking force varies from 0.1 N to 1 N maximum. The plastic shrinking force reaches a maximum in the shrink tunnel followed by a decrease in force as a result of relaxation (some of the entanglements of the LDPE resin start to disentangle).

The degree of relaxation depends on the temperature and the dwell time in the shrink tunnel: the higher the temperature and the longer the dwell time, the greater the relaxation. After leaving the shrink tunnel, the film cools off rapidly and the thermal shrinkage starts. The starting temperature of the thermal shrinkage is the solidifying point of the resin. The film is now tightened around the packed article, the thermal shrinkage is obstructed (geometric hindrance) and the thermal shrink force is built up.

Fig. 13 Course of the shrink force in the shrink tunnel at a temperature of 140°C. Since the plastic shrink force proceeds much more rapidly than the thermal shrink force the course of the forces is expressed in different units of time, seconds and minutes respectively.

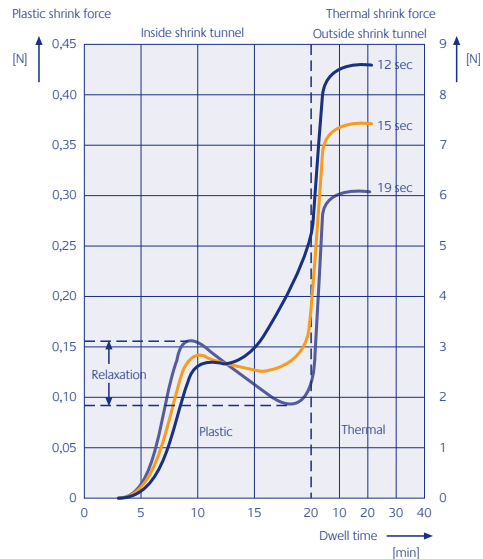



This takes place in the solid phase of the material and therefore the thermal shrink forces are high. Dependent on the polyethylene grade (= MFR, see fig. 33), the shrink percentage, the film thickness and the relaxation in the shrink tunnel (see fig. 23) the thermal shrink force varies from approx. 0.2 N to a maximum of approx. 12 N.

The lower the plastic relaxation, the higher the thermal shrink force (see fig. 13).

When the tensions are calculated from the shrink forces (which is done by dividing the tensions by the original diameters) it appears that the plastic shrink tension varies between 0 and approx. 0.4 N/mm² while the thermal shrink tension ranges between 0.2 and approx. 4.0 N/mm² depending on the SABIC[®] LDPE grade, the shrink percentage and shrink conditions.

Shrinkage of the film in the shrink tunnel is always a combined result of the film thickness, film orientation, the air temperature and the dwell time. The maximum shrinkage in machine and transverse direction that can be obtained for the different films can, in principle, be measured (see the chapter on the measurement of the shrink percentage). In practice, however, these maximum values are never obtained. Fig 14 shows that higher shrink percentages can be obtained when, at a certain temperature (measured in silicon oil), the dwell time is extended or when, at a certain dwell time, the temperature is raised.

In other words, a shrink percentage of e.g. 65% can be obtained at a high temperature and a short dwell time (e.g. 160°C and 30 seconds respectively); or at a low temperature and a long dwell time (e.g. 120°C and 3 minutes respectively).

Fig. 14 Relation between temperature and dwell time at a constant shrink percentage. Film thickness 100 microns; die 80 mm; die gap 0.5 mm; BUR 2.0.

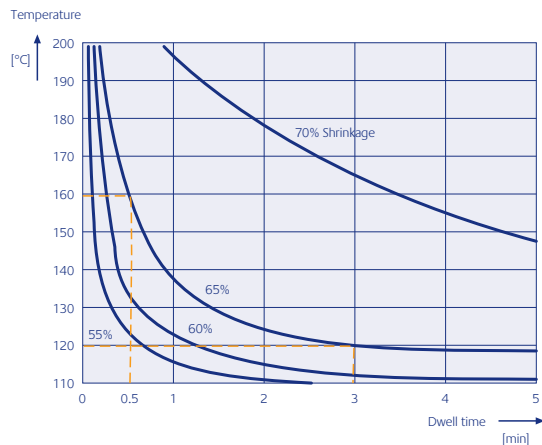

In practice this means that, if insufficient shrinkage of a film occurs, the dwell time can be prolonged whilst the temperature remains at the same level (this gives loss of production) or the temperatures can be raised while the dwell time remains constant.

The increase of the air temperature to achieve a shorter dwell time in the shrink tunnel cannot be endlessly without penalties. At higher air temperatures the danger of holes appearing in the film - especially thin films or films of uneven thickness - is increased.

To build up a high thermal shrink tension, it is advantageous if little relaxation takes place. This means that, to obtain strong bundling forces, only the space between the wrap and packed article should be shrunk away and the film should be cooled immediately. This is visible in the shrink tunnel because at this particular dwell time, the film just reaches the geometry where it exactly fits around the packed article.

When on the contrary low thermal shrink forces are desired, e.g. when packing a single magazine, it is necessary to ensure that the film relaxes as much as possible.



Measuring shrink

Measuring the shrink percentage

SABIC developed a method for measuring the unloaded shrink in machine and transverse direction simultaneously (see fig. 15). In this method test strips of 100 x 100 mm are immersed in heated silicon oil (temperature controlled). The shrink percentage in machine and transverse direction is determined, as a function of the dwell time (from the moment of immersing). The shrink percentage can be determined without taking the strips out of the bath. Contrary to other methods (e.g. the glycol-bath method) the thermal shrinkage is not included in the shrinkage indicated. For SABIC® LDPE film grades, the standard temperature is fixed at 125°C.



Fig. 15 Measuring shrinkage in a silicon oil bath.

Initially the shrink percentage increases rapidly; later on shrinkage increases at a lower rate until eventually a maximum value is achieved (see fig. 16).

The point where the shrinkage practically does not increase anymore is called the potential shrink percentage of the film. For thin films, this point is reached after shorter dwell times than for thick films (see fig. 16, dotted line).

This means that, at the same temperature, thick films need longer dwell times than thin films to obtain good shrinkage. Therefore, when measuring the shrink percentage at one dwell time, one has to take into account that thicker films need a longer dwell time.

Fig. 16 Influence of dwell time on shrink in machine direction, for various film gauges (MFR 2, density 921); die 80.0 mm; die gap 0.5 mm; BUR 2.0. Temperature of the silicon oil is 125°C.

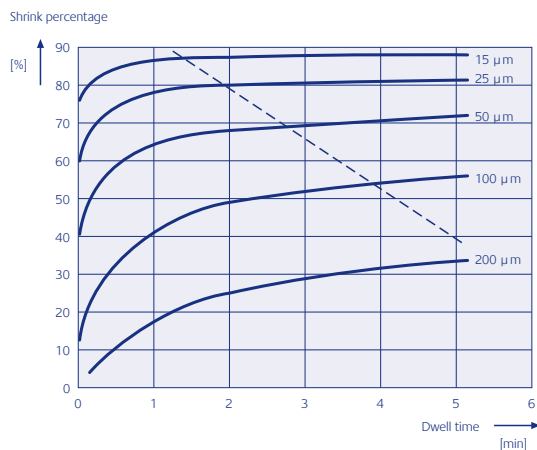
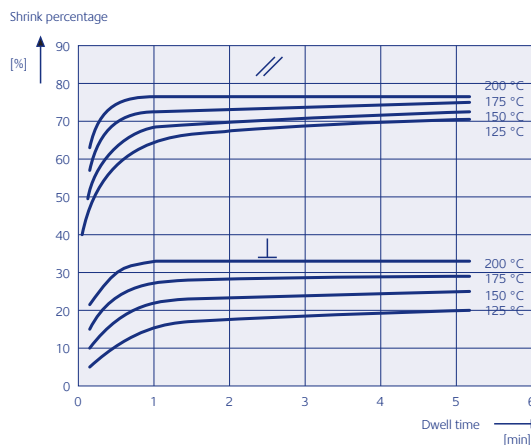

Fig. 17 Influence of the dwell time on the shrink percentage at various temperatures (MFR 2, density 921); die 80.0 mm; die gap 0.5 mm; BUR 3.0; film thickness 50 microns.



The shrink percentage in silicon oil can be measured at several temperatures (see fig. 17). The higher the temperature, the more rapid the shrinkage of the film will be and the greater the potential shrink percentage.

To establish the practical use of a shrink percentage measured in silicon oil, the shrinkages of a film were measured in the shrink tunnel and in the silicon oil bath. The outcomes were compared subsequently.

It appears that, at the same temperature, the film in the oil bath shrinks more rapidly, due to the better transfer of the heat (fig. 18). At longer dwell times, the percentage obtained in the tunnel is comparable to the value measured in the oil bath. When we regard dwell times that are used in commercial shrink tunnels,

Fig. 18 Shrink percentage as a function of the dwell time in the shrink tunnel and the silicon oil bath at 125°C. Film thickness 50 microns.

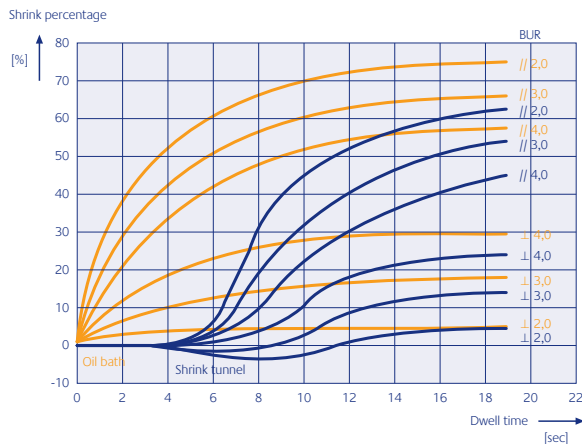

between 10 and 60 seconds, the shrink percentage in the oil bath is always higher than that of the shrink tunnel (given equal temperatures). When the shrink percentages measured in the oil bath at 125°C are compared with the percentages measured in the tunnel at several temperatures, it appears that with a tunnel temperature of 160°C, the same shrinkage is obtained as in the oil bath of 125°C. See fig. 19.

Above a temperature of 160°C the shrinkage in the tunnel is higher than in the oil bath at 125°C and below 160°C the shrinkage in the tunnel is lower than in the oil bath at 125°C.

Since the shrink tunnel conditions are not known on beforehand, it would be best to determine the potential shrink percentage at a standard temperature.

For measuring the shrink percentage of SABIC® LDPE shrink film, a temperature of 125°C has proved to be sufficient.

Fig. 19 Shrink percentage in a silicon oil bath at 125°C compared with the shrink percentage in a shrink tunnel at various air temperatures. Film thickness 50 microns; dwell time 20 seconds.

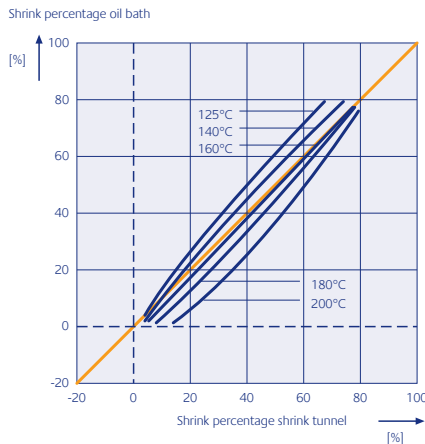

Measuring the shrink tension

In evaluating the quality of shrink film, a great deal of attention is given to the total amount of free longitudinal and transverse shrinkage available in the product. However, this criterion is inadequate for a full characterisation because in practice the film will shrink until it meets the boundaries of the object being packed; given the right film dimensions. At this point further shrinkage is impossible, and a shrink force will build up in the film. The amount of shrink force needed or allowed depends largely on the object to be shrink-wrapped. For easy deformable objects (e.g. aluminium dishes) it is desirable to have a low shrink force, whereas heavy objects (such as bricks on a pallet) require a high shrink force.

Knowledge relating to the variation in shrinkage and shrink force with the temperature is essential to get the correct shrink film for a given use. This is why SABIC has developed a test unit enabling the shrink tension to be measured as a function of the temperature.

The unit's working principle has been laid down in DIN Standard 53369. The shrink force is measured with a transducer and visualized, through an amplifier, on a pen recorder along with the temperature (see fig. 21).

The shrink tension is calculated by dividing the shrink force by the original section area of the test strip.

The shrink tension can be measured with two methods:

1. The test sample is placed in a cold oven, which is then heated at a constant rate (say, 120°C per hour).
2. The test sample is placed briefly in a hot oven (say, at 180°C) and subsequently cooled down to room temperature.

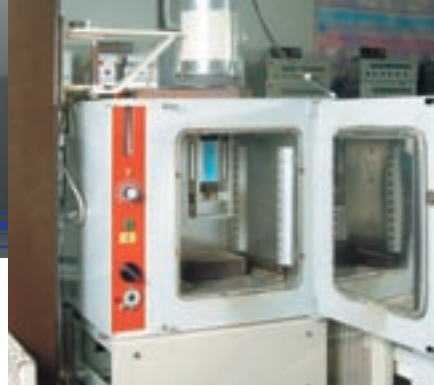

Fig. 20 Test unit developed for determination of shrinkage and shrink force.

Because the second method is comparable to the circumstances in a shrink tunnel, this is the only method with practical value.

The plastic and thermal shrink tensions measured for a given film are influenced by:

1. The permissible free shrinkage
2. The dwell time in the oven
3. The temperature in the oven.

Fig. 21 Diagram of the shrink tension tester.

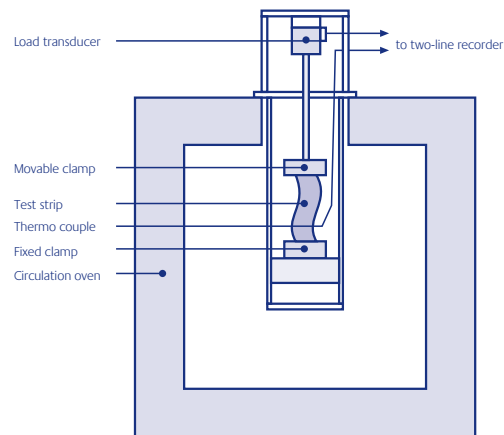



The amount of free shrinkage can be varied by using test strips of uniform length (say 100 mm) and varying the length of the test clamp distance. The more free shrinkage is allowed (fig. 22), the larger the proportion of film orientation absorbed will be in shrinking away the slack between the clamps before the film starts to pull at the load transducer. This leaves less orientation available for building up the plastic and thermal shrink tension. However, during the shrinking process, the thickness of the remaining film increases. This results in a slower cooling rate as a consequence of which crystallization and thermal shrinkage also increase; the thermal shrink tension increases.

Fig. 22 Effect of the permissible free shrinkage on shrink tension for SABIC® LDPE (MFR 2, density 921). Film thickness 100 microns; temperature 140°C; dwell time 12 seconds.

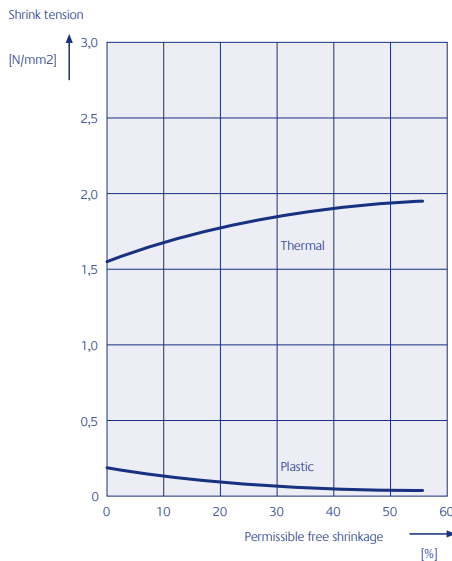

Thus an increase in permissible free shrinkage goes hand in hand with lower plastic shrink tension and higher thermal shrink tension. In actual practice there is approximately 10% free shrinkage, namely the shrinkage of the wrap before it lies closely around the object being packed; for this reason all shrink tension figures mentioned in this brochure have been established on the basis of 10% permissible free shrinkage.

As is shown in fig. 13, the thermal shrink tension decreases when the relaxation in the plastic phase increases; in other words the dwell times in the shrink tunnel are longer (fig. 13: difference between 12-second and 19-second dwell times in tunnel). The highest thermal shrink tension at a given shrink tunnel temperature (say 140°C) is reached when the applied dwell time does not induce any relaxation (in fig. 13 this would be 12 seconds). During the dwell time at which the maximum thermal shrink tension is obtained, the exact amount of space available between the film wrap and the object being packed has shrunk away, and the remaining orientation in the film is used completely for building up the thermal shrink tension. At shorter dwell times, the film will shrink to a lesser extent so that part of the available thermal shrink percentage is used in tightening the wrap and a lower thermal shrink tension is obtained. Longer dwell times will produce film relaxation and, therefore also induce a lower thermal shrink tension. See fig. 13 at 15 seconds and 19 seconds. This variation in thermal shrink tension as a function of dwell time is reflected in fig. 23 at different air temperatures.

Notice that the thermal shrink tension curve has the same peak value at each air temperature. With increasing temperatures, this peak value merely shifts towards shorter dwell times. Although the temperatures and dwell times involved were established by means of a shrink tension gauge and do not apply to a shrink tunnel (in which the film is exposed to a different, one-sided, heating process), the same general tendency will be found in such a tunnel.

Fig. 23 Effect of dwell time on thermal shrink tension of SABIC® LDPE (MFR 2, density 921). Film thickness 100 microns; BUR 1.5; Temperatures 120°C, 140°C, 160°C, 180°C and 200°C.

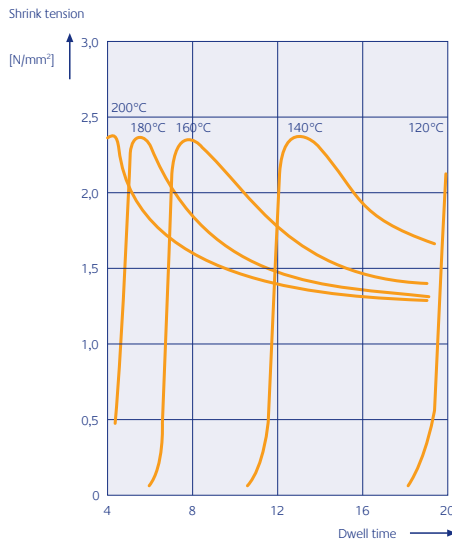

For practical situations, this implies that a low shrink tunnel temperature and a long dwell time will give the same thermal shrink tension as a high shrink tunnel temperature and a short dwell time (a similar interrelation has been established for the shrink percentage).

In selecting the shrink tunnel temperature and dwell time, care should be taken to ensure that the space between film and packaged objects has just been removed by shrinkage when the shrink-wrapped product arrives at the tunnel outlet.

Fig. 24 Effect of the dwell time on shrink tension in the direction of extrusion for SABIC® LDPE (MFR 2, density 921). Film thickness 50 microns; temperature 140°C; stretch in machine direction 2.5, 3.3, 5.0 and 6.7.

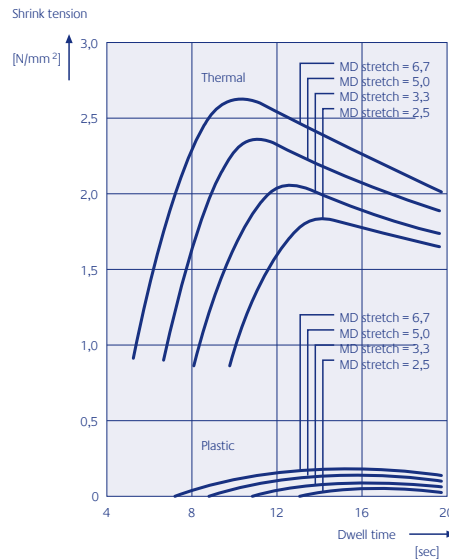



The peak in the thermal shrink tension curve (i.e. the optimum value for a film's thermal shrink tension) appears to be characteristic for the film grade used. This peak reflects the point that longer dwell times will produce film relaxation and, therefore, lower thermal shrink tension. See fig. 13 at 15 seconds and 19 seconds.

This point also indicates that all the orientation present in the film is used for building up the thermal shrink tension. Thus in films having a different orientation (e.g. as a result of variations in orientation in the machine direction) a different value is found for the optimum shrink tension (see fig. 24). Since in principle it matters little at what temperature the shrink tension is determined (provided the dwell time selected permits measurement of the optimum thermal shrink tension), such determination should preferably take place at the temperature applied to the film in the shrink tunnel.

There is a relationship between the amount of orientation present in a film and the film's optimum thermal shrink tension. Since the same is true of the orientation and the shrink percentage, there must also be a relationship between the shrink percentage and shrink tension.

This relation is virtually linear. Thus when the longitudinal and transverse shrink percentage are known for a film blown from a given SABIC® LDPE type, it is possible to establish the film's approximate thermal shrink tension in both directions (see example in fig. 25).

The shrink tension depends not only on film orientation but also on the MFR and density of the resin used. This is explained in the following section.

Fig. 25 Thermal shrink tension as a function of the shrink percentage for SABIC® LDPE (MFR 0.3, density 922), SABIC® LDPE (MFR 0.8, density 922), SABIC® LDPE (MFR 2, density 921).

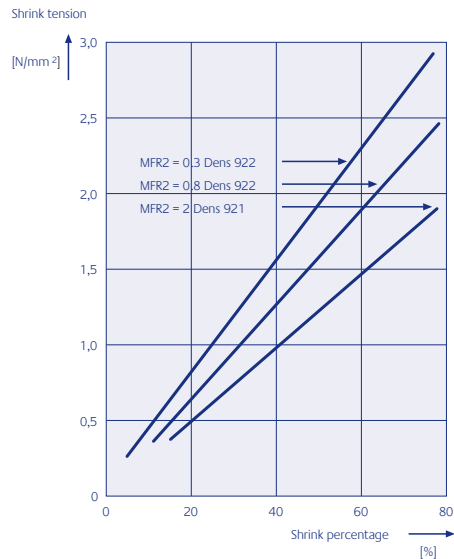



The blown film process of LDPE for shrink film

The shrinkage of SABIC® LDPE film is a result of the orientation in machine and transverse direction introduced during the manufacturing process (blown film). When heated to a temperature of 110-120°C, the film shrinks until the oriented molecular structure has almost disappeared.

This means that each blown LDPE film has latent shrink properties. The particular feature of shrink film is that the processing conditions are chosen in such a way that the film has exactly the right shrink properties for optimum packaging possibilities.

Orientation

During the manufacturing process for blown film, orientation is caused by:

1. The stretching of the material because it is blown up like a balloon after it flows out of the circular die (fig. 26). During this stretching, the material is cooled off by air (by means of the air ring) until the solidifying point is reached. From this point - known as the frost line of the bubble - the material is not stretched any more and no further orientation takes place.
2. The flow of the material in the extrusion die: on its way to the die outlet the material flows through narrowing channels, which causes orientation of the long chain molecules, mainly in the direction of the flow.

Naturally, the orientation produced as the material flows through the extrusion die is influenced by the geometry of the flow channels in the die. Thus a narrowing channel will accelerate the flow and therefore the orientation is higher. In a cylindrical channel the flow rate remains constant, so that relaxation can occur and the orientation is reduced. This happens at the die land. A long land gives more relaxation and, consequently, less shrinkage than a short one. Also the die gap influences the amount of flow orientation: a wide gap at the die land allows less flow orientation and more relaxation than a narrow gap. Remember though that, with a given thickness and blow-up ratio, due to the increasing longitudinal stretch a gap of 1.0 mm will give more shrinkage in the machine direction than a gap of 0.5 mm. (see formula 2 and fig. 27). The difference, however, is smaller than one would expect: a 1 mm die gap introduces much less flow orientation into the melt than a 0.5 mm die gap. The effect of flow orientation is higher than the effect of stretch orientation!

An abrupt increase in diameter of a flow channel causes an orientation increase perpendicular to the extrusion direction, and therefore, greater transverse shrinkage. This phenomenon occurs in extrusion dies having a mushroom shaped core. The higher the ratio between gap diameter and die bush diameter, the larger the amount of transverse orientation introduced into the melt and thus a higher transverse shrinkage (see fig. 26).

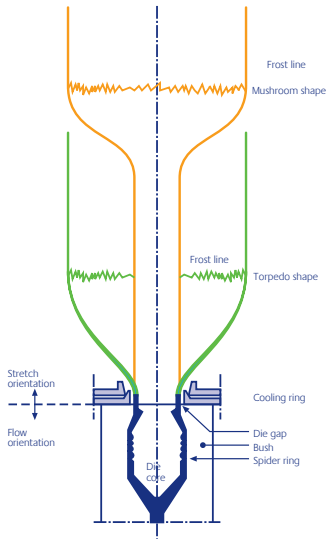

Fig. 26 Orientation during film manufacturing.

Influence of MFR

Orientation in machine and transverse direction decreases as the viscosity gets lower (better flow due to a higher MFR or a higher polymer temperature).

The amount of stretch of the material after leaving the die can be calculated and consequently used as a measure for orientation and, therefore, for shrinkage.

The total stretch equals the stretch in machine direction (MD stretch) multiplied by the stretch in transverse direction (TD stretch). It also equals the ratio between die gap width multiplied by swelling, and film thickness (see formula 1).

Formula 1: the calculation of total stretch

$$\text{MD}_{\text{stretch}} \times \text{TD}_{\text{stretch}} = \frac{\text{die}_g \times \text{die}_s}{\text{th}}$$

Where:

- $\text{MD}_{\text{stretch}}$ = the amount of stretch in machine direction
- $\text{TD}_{\text{stretch}}$ = the amount of stretch in transverse direction
- die_g = die gap [mm]
- die_s = amount of die swell [mm]
- th = thickness of the film [mm]

In practice the amount of die swell (die_s) can be overlooked, since in general it is very small and is mainly affected by the die gap width. The blow-up ratio (BUR) is a measure of the stretch in transverse direction (see formula 2)

Formula 2: calculation of the blow-up ratio (BUR)

$$\text{BUR} = \frac{\text{bubble}_d}{\text{die}_d} \quad \text{TD}_{\text{stretch}} = \text{BUR} \times \text{die}_s$$

Where:

- BUR = blow-up ratio
- bubble_d = bubble diameter [mm]
- die_d = die diameter [mm]

Since the BUR is not dependent on the die gap, formula 1 can be rewritten as follows (again die swell can be overlooked):

Formula 3: calculation of the MD stretch

$$\text{MD}_{\text{stretch}} = \frac{\text{die}_g}{\text{th} \times \text{BUR}}$$

Where:

- $\text{MD}_{\text{stretch}}$ = the amount of stretch in machine direction
- die_g = die gap [mm]
- th = thickness of the film [mm]
- BUR = blow-up ratio

Fig. 27 Influence of the die gap on the shrink in machine direction for SABIC® LDPE (MFR 0.8, density 922). Die gap of 0.5 mm and 1.0 mm. BUR 2.0.

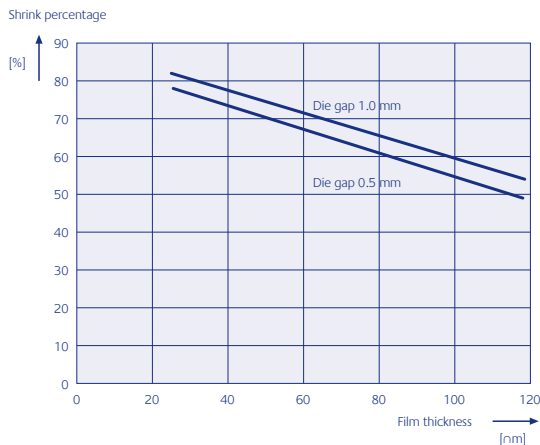

Orientation as a result of the flow of the material in the extrusion die can hardly be estimated quantitatively, since it is very dependant on the design of the die (geometry). However, it is possible to indicate how this orientation can be affected.

Orientation in machine direction increases when:

- the acceleration of the flow in the die increases (higher shear velocity)
- the polymer temperature decreases or increase of cooling capacity.
- through-put increases (greater flow velocity).

Influence of processing conditions on MD shrinkage

MD shrinkage is dependent mainly on MD stretch, given constant die geometry. Higher stretch levels cause more orientation, with a higher shrinkage as a result (see fig. 28). In this case MD shrinkage, as a function of MD stretch, is obtained by varying the thickness of the film, the other conditions remaining constant.

At an MD stretch of 1 (film thickness = die gap width at a BUR of 1.0) some MD shrinkage already occurs. This is the result of the pre-orientation caused by the flow in the die.

It is found that in practice MD stretch can vary between 1.25 and 25. From this it can be derived that it is no problem at all to get a sufficient MD shrinkage: in general the MD stretch will be more than 2.0.

Deviations from the shrink behaviour shown in fig. 28 are caused mainly by the production rate and by differences in the amount of swell:

- **Production rate:** higher flow orientation occurs at higher flow velocities in the die, which causes an increase in MD shrinkage and a lower TD shrinkage (other conditions kept constant). When the rate of production is increased it becomes more and more difficult to manufacture shrink film with a high TD shrinkage (more than 40%). The influence of the production rate is less with thin films.
- Differences in the amount of die swell can originate from temperature variations in the extruder and from differences in the molecular structure of the material. The effect is minor compared to that of the production rate and stretch.

Fig. 28 MD and TD shrinkage of SABIC® LDPE (MFR 0.3, density 922) as a function of the stretch ratio (die./thickness)

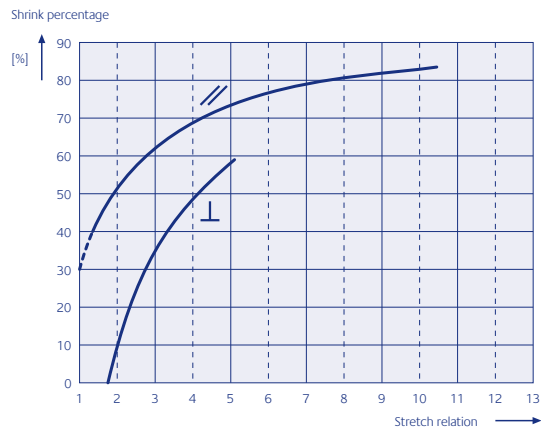

Influence of processing conditions on TD shrinkage

TD shrinkage is mainly dependent on the blow-up ratio. A higher blow-up ratio gives greater orientation and a higher TD shrinkage as a result (fig. 29).

When, at a constant thickness of the film, the blow-up ratio is increased, MD stretch and MD shrinkage decrease (see also formula 2). This phenomenon is also shown in fig. 29. At a certain blow-up ratio, MD shrinkage and TD shrinkage will have the same value. For thick film, this intersection is reached at a lower blow-up ratio than for thin film. This means that it is easier to manufacture bi-axial shrink film using thick film. The TD shrinkage may then even exceed the amount of MD shrinkage.

Fig. 29 MD and TD shrinkage of SABIC® LDPE (MFR 0.8, density 922) as a function of the blow-up ratio for several film thicknesses. Die 80.0 mm; die gap 0.5 mm.

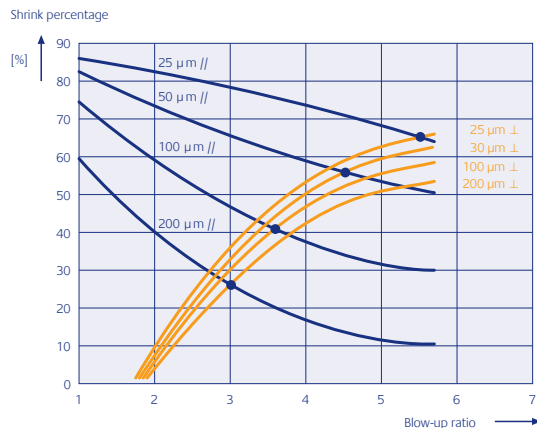

TD Expansion

When the MD stretch is high (thin film) and the TD stretch is small (<1.5) a negative TD shrinkage (i.e. transverse expansion) can occur. This expansion is a result of the MD shrinkage, which in turn is the result of the material that is pushed in the width of the bubble. Normally the material, which is shrinking in MD and TD direction, would increase in thickness. In this case, however, the material has only very little TD orientation, and does not shrink in TD direction. The consequence is an increasing width of the film.

TD shrinkage is also dependent on other factors. When combined these factors have a considerable influence:

- **Stretch rate:** the highest rate of stretch at the lowest possible film temperature causes the highest degree of orientation and the least relaxation of the orientation, which results in the greatest shrinkage. This occurs in a mushroom-shaped bubble (fig. 30). In such a bubble TD stretch is realised in a very short length just beneath the frost line at a relatively low temperature. The mushroom shape gives approximately 10% more TD shrinkage than the usual torpedo shape. The mushroom-shaped bubble can be obtained when the amount of cooling air is very well tuned to the amount of material to be cooled.

- **Frost line height:** when, at a certain diameter of the bubble, the frost line is raised the bubble takes the shape of a mushroom. The optimum frost line height, whereby the maximum rate of stretching is obtained with preservation of the bubble stability, can be set, as a rule of thumb, to a value which is 0.8 to 1.0 times the width of the flat-laid film.

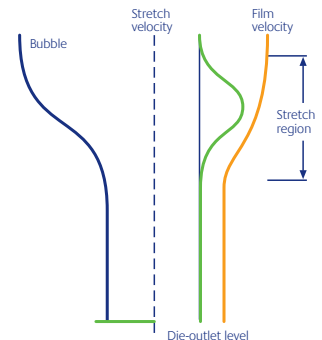

Fig. 30 Stretch rate and film velocity in the mushroom shaped bubble.

- **Production rate:** when the frost line is raised and the torpedo shape preserved, which would be the usual procedure followed in stepping up the rate of production, TD stretch will occur at higher temperatures, so that TD shrinkage decreases.
- **Bubble stability:** the methods which, in practice are generally adopted to achieve bubble stability, and which are based on the Venturi effect, reduce the height above the gap at which TD stretch takes place. As a result TD stretch occurs at a higher temperature and less TD orientation is induced in the film.
The Venturi effect can be generated by placing a diaphragm on the cooling ring or by imparting a Venturi shape to the cooling-ring air gaps. Both methods will lead to a reduction in TD shrinkage.
- **Film thickness variations:** when the die gap is insufficiently uniform, and when there are differences in temperature around the die gap, and differences in the amount or the temperature of the cooling air, differences in thickness of the film may occur. As a result there will be differences in TD orientation and consequently differences in TD shrinkage (see fig. 31). To obtain an evenly shrinking film it is therefore important that the differences of the thickness of the film are as small as possible; preferably less than 5%.

Influence of the grade characteristics on shrink properties

Of the two characteristic properties of a LDPE grade, density and MFR, the density has practically no influence on shrink behaviour. The MFR, on the other hand, has a considerable influence on the shrink properties. The MFR is a measure of the molecular length and viscosity of the material. These two factors determine:

- the degree to which the material can be oriented when it flows in the die
- the ability to stretch the material after leaving the die until it reaches the solidifying point (frost line height).

Fig. 31 Influence of the distribution of the film thickness on TD shrinkage. The thickness was measured on 16 places in the circumference of the film. The used film showed unusually great differences in film thickness.

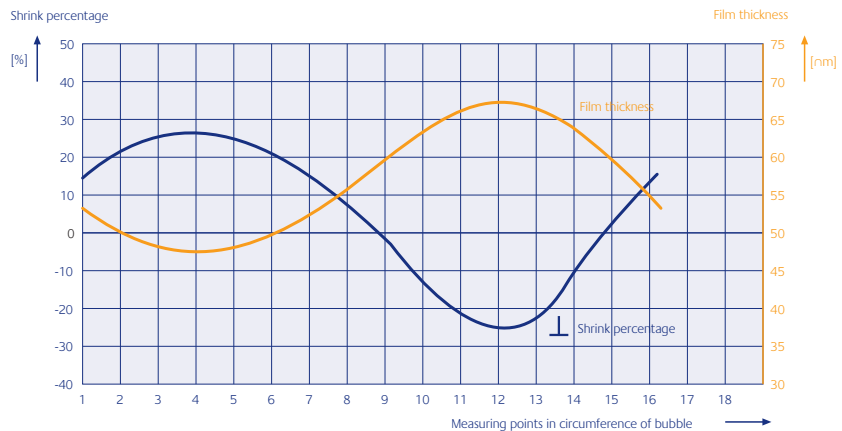

The lower the MFR, the more orientation can be brought in the material and the more the film will shrink; provided that the various materials are processed under the same conditions. Fig. 32 shows that the MFR has a greater influence on TD shrinkage than on MD shrinkage. This can be explained by the fact that orientation in machine direction is always higher than in transverse direction.

As a higher orientation causes a higher plastic and thermal shrink tension, a polyethylene grade with a lower MFR obviously shows higher shrink tensions. See also fig. 33 in which the optimum plastic and thermal shrink tensions are given as a function of the MFR for films with different amounts of MD stretch. The latter is obtained by varying the BUR.

Fig. 32 Influence of the MFR on the shrink percentage. Die 80.0 mm; die gap 0.5 mm. Film thickness is 50 microns.

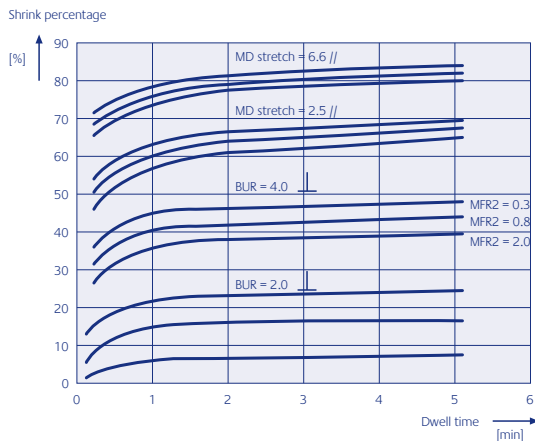

When there are high demands on the bundling force for a certain application (e.g. high shrink tension for pallet hoods) a polyethylene grade with a low MFR, such as SABIC® LDPE MFR 0.3 [g/10min] and density 921 [kg/m³] should be used. In practice, however, not only good shrink properties but also good optical properties or high tear resistance and toughness are desired. The shrink properties of the SABIC® LDPE grades in general can fulfil all the different demands in today's shrink film applications; provided that the correct processing conditions are chosen.

Fig. 33 Influence of the MFR on the shrink tension in machine direction (MD). Die 80.0 mm; die gap 0.5 mm. Film thickness is 50 microns.

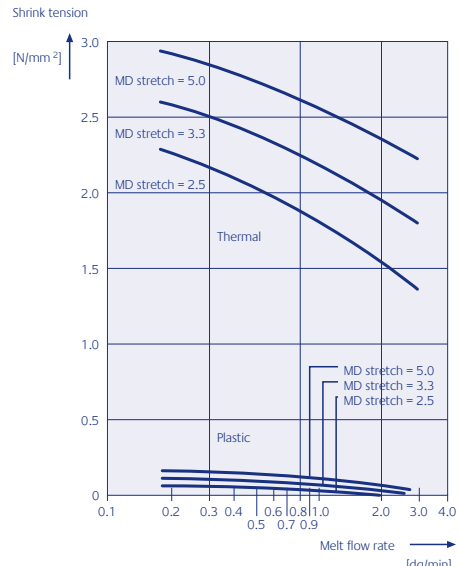

MD and TD shrinkage of SABIC® LDPE film

The calculations for MD and TD stretch are visualized in figs. 34 and 35.

For some SABIC® LDPE grades the shrink properties are determined at various stretch ratios in MD and TD. Fig. 34 gives an indication of what BUR should be chosen to obtain the desired TD shrinkage. In addition the diameter of the die can be found if the width of the flat-laid tube and the BUR are known.

Fig. 35 shows the MD shrinkage when film thickness, die gap and the BUR (derived from fig. 34) are known. Conversely, one can see which die gap should be chosen to obtain the desired MD shrinkage.

Calculation examples

a. Shrink film for small articles

Demands:

- TD shrinkage 40%
- Film thickness 25 microns
- Film width 600 mm

Variables:

- Polyethylene grade
- Dimensions of die width
- Dimension of die gap

Solution:

In view of the application demands, preference is given to SABIC® LDPE MFR 2 [g/10min] and density 924 [kg/m³] (if needed an additivated grade can be chosen).

Fig. 34 shows that such a grade can be processed at a BUR of about 4 to obtain a TD shrinkage of 40%. For the desired width of the film (600 mm) a die with a diameter of 100 mm is required. For a film of 25 microns the smallest die gap can be used.

The MD shrinkage is expected to be 65% (fig. 35).

b. Shrink film for pallet hoods

Demands:

- MD shrinkage 55%
- TD shrinkage 50%
- Film thickness 150 microns
- Film width 2500 mm

Variables:

- Polyethylene grade
- Dimensions of die width
- Dimension of die gap.

Solution:

To obtain an optimum combination of bubble stability, shrink force and mechanical properties the grade with the lowest MFR is preferred: SABIC® LDPE MFR 0.3 [g/10min] and density 921 [kg/m³].

Fig. 34 shows that for such a grade, a BUR of about 4.2 is necessary to obtain a TD shrinkage of 50%. For the desired film width (2500 mm) a die of 380 mm diameter should be chosen.

Starting from a MD shrinkage of 55% (see fig. 35) and the BUR derived from fig. 34 it appears that a die gap width of 1.0 mm gives a film with sufficient bi-axial shrink properties.

Note:

At the shrink percentages indicated a spread of ± 5% (absolute shrinkage) must be taken into consideration for the TD shrinkage, and ± 2.5% for the MD shrinkage. This implies that approximately 95% of the values measured lay within a band width of respectively 10% and 5% shrinkage.

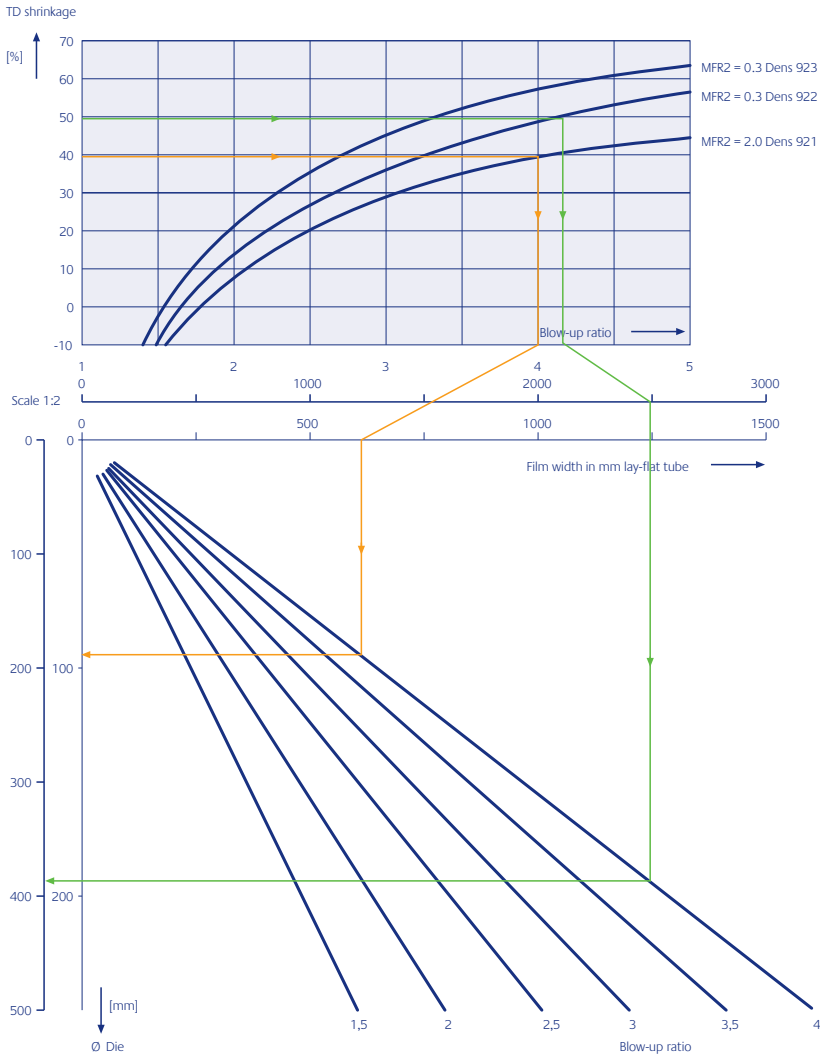

Fig. 34 Example nomogram for the determination of the BUR and die width.



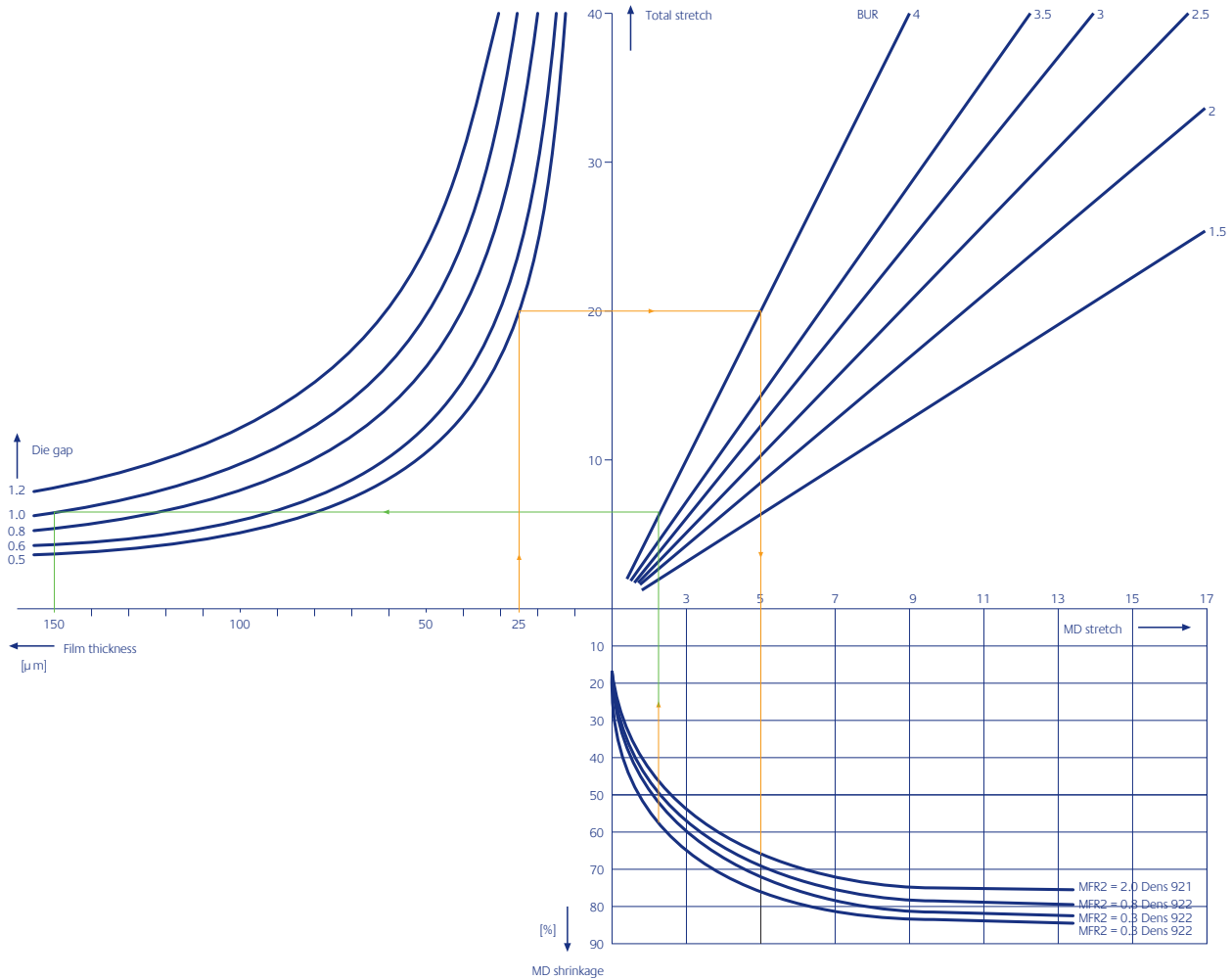

Fig. 35 Example nomogram for the determination of the die gap or reversely MD shrinkage.

Shrink film defects

When an object is shrink-wrapped, several types of film failure may occur during the process. For example shrinkage may be insufficient, holes may develop in the film, welds may tear, perforations may grow into round holes, the film may fold or crease, pallet wraps may work loose from the pallets, etc. Most of these defects are the result of a not optimal shrink wrapping process.

Inadequate shrinkage

Since almost every shrink film grade allows more free shrinkage in each direction than the required 10%, inadequate shrinkage is nearly always caused by a too short dwell time in the shrink tunnel, or by a too low oven temperature (see fig. 14).

Variations in shrinking behaviour within a film, or between two films with the same specifications, are usually the result of differences in film thickness.

A thick film needs a longer heating time than a thin film (see fig. 16), this means that, at the same dwell time, the thick film will show less shrinkage than the thin film.

Furthermore considerable variations in shrinkage can arise through heat discharge from the shrink film to the object wrapped in it. Areas in contact with the wrapped object remain colder and therefore will shrink less (if at all) than areas where such contact is not present.

Holes and tears

Shrink film or film welds may tear due to excessive temperatures, excessive shrink tension, or a combination of both.

First of all when a shrink film shows great differences in thickness the thin spots will absorb far more heat than the surrounding thicker material. These very weak (low viscosity) spots become so hot that they will tear due to the high plastic shrink tension in the surrounding areas. The chance of such failure is most probable in shrink films with considerable differences in thickness and high plastic shrink tension levels.

Excessive heating may also occur in areas where the shrunk film is free of the wrapped object and where a large amount of air is blown onto the material. This situation may arise in shrink ovens with poor air distribution. This type of failure is encountered mostly when a high temperature is used in the oven. When the free film remains too long in the plastic shrinkage phase perforations produced by the plastic shrink tension will tend to become larger and develop into nice, round, but undesirable holes. Thus it is advisable not to use a higher temperature or a longer heating time than is required to remove the space between wrap and object by shrinkage.

Secondly, when the film cools down the thermal shrink tension may rise to the extent of tearing the material apart in areas subjected to concentrated loads (caused by sharp edges on the object being shrink wrapped), areas where the film has sustained damage (tear initiation), weak areas (resulting from gels, flow lines, lack of homogeneity) and at defective welds.

These latter phenomena can be made visible quite clearly with the aid of double-polarized light. Films having a low thermal shrink tension and low intrinsic tear resistance are most likely to develop the type of failures just described.

Folds and creases

For a film to shrink properly it must be heated until it is in the plastic phase. This is also the phase in which the film can be welded. When a film fits loosely around the object being packaged and shrinks slowly, which will be the case when the shrink percentage is low, fusion may occur before the space between wrap and object has been removed by shrinkage. This in turn will lead to folds and creases in the shrink film.

Since the failure involved is caused by the wrap being too large, it can be solved by using a wrap of smaller circumference (i.e. less than 10% in excess of the object circumference). When the object to be shrink-wrapped has a very irregular shape, crease forming is generally very hard to avoid. However, aside from the visual aspect, this will not affect the quality of the package produced, provided the weld is reasonably strong.

Effect of processing conditions and material properties on shrink film property				
	MD shrinkage	TD shrinkage	MD shrink force	TD shrink force
increased MD stretch	↗	↗	↗	↗
higher blow-up ratio	→	↗	→	↗
wider die gap	→	→	→	→
greater orifice land length	→	→	→	→
thicker film	↘	→	↘	→
increased production rate	→	→	→	→
higher polymer temperature	→	→	→	→
increased stretching rate	→	→	→	→
higher frost line				
torpedo shape	→	→	→	→
mushroom shape	→	→	→	→
higher melt index	→	→	→	→
higher density	→	→	→	→
Key:	↗	→	↘	
	increases (a steeper incline denotes a heavier increase)	remains unchanged	decreases (a steeper incline denotes a heavier decrease)	

Fig. 36 Effect of processing conditions and material properties on the shrink film behaviour.

Film properties of SABIC® LDPE grades in use for shrink film

SABIC LDPE	MFR 2.16	Density	Gloss	Haze	Clarity	Impact strength	Tear strength MD	Tear strength TD	Remark
Test method	ISO 1133/2005	ISO 1183 (A)	ASTM D 2457	ASTM D 1003A	SABIC method	ASTM D 4272	ISO 6383-2	ISO 6383-2	
Unit	g/10 min	kg/m ³	%	%	mV	kJ/m	kN/m	kN/m	
2100TN00	0.3	921	45	12	50	30	30	30	
2100TN21	0.3	921	40	15	50	30	45	25	
2200TC00	0.3	922	57	8	25	30	35	40	
2200TC12	0.3	922	57	9	27	30	35	40	
2500TN00	0.4	925	47	11	40	20	35	40	
2600TC00	0.3	926	57	8	25	25	35	45	
2101TN00	0.85	921	55	9	30	25	40	30	
2201TH00	0.85	922	68	6	15	25	55	45	
2201TH12	0.85	922	65	6	17	25	45	45	
2501TN00	0.75	925	55	10	25	15	45	45	
2501TH00	0.75	925	65	7	15	15	55	55	
2102TX00	1.9	921	53	10	26	20	70	25	25 µm film
2402TC32	2.5	924	55	10	22	15	80	30	25 µm film
2404TC43	4.7	924	50	11	28	13	90	30	25 µm film
2602TH00	1.9	926	64	7	12	15	90	40	25 µm film

Film properties have been measured at films with a thickness of 50µm, produced with a BUR of 3.

The films have been produced on a Kiefel IBC Blown Film line, at an output rate of 200kg/hr with a die of 200mm and a die gap of 0.8mm. Shrink properties are dependant on chosen processing and hardware conditions.

